

**EXCHANGE**

CHICHESTER STREET BELFAST

INTRODUCING  
A BRIGHT NEW  
CITY SPACE

**THE  
PAPER  
EXCHANGE**

INTRODUCING  
A BRIGHT NEW  
CITY SPACE

# CONTENTS

## **07 KEY FEATURES & AREA SPECIFICATION**

## **08 STORY**

- 11 WHERE GOOD THINGS ALIGN
- 12 LOCATION
- 14 AT THE HEART OF THE CITY

## **20 SURROUNDS**

- 22 LIFE IN BELFAST
- 24 EAT
- 28 STAY
- 32 BUSINESS ARENA
- 34 TALENT
- 36 TECH, FINANCE & PROFESSIONAL SERVICES

## **40 SPACE**

- 50 AREA SPECIFICATION
  - 51 SUMMARY SPECIFICATION
  - 52 FLOOR PLANS
- 

- 74 IN-DEPTH SPECIFICATION
- 80 PROFESSIONAL TEAM
- 83 CONTACT



Gratchev St.

THE PAPER EXCHANGE

# INTRODUCING A BRIGHT NEW BELFAST CITY SPACE



# INTRODUCING

The Paper Exchange comprises 11 storeys & 155,133 sq ft of grade A office accommodation at the heart of all Belfast city has to offer.

FLOORPLATES FROM

**7,115** SQ FT  
TO  
**16,975** SQ FT

**DOUBLE HEIGHT  
ENTRANCE LOBBY**

**7 LIFTS**  
6 x 17 PASSENGER  
& 1 GOODS LIFT



**4,000** SQ FT  
PRIVATE TERRACE  
ON 8TH FLOOR

**85**  
BICYCLE  
SPACES

**15**  
CAR SPACES

AVERAGE LIFT WAITING TIME < 25 SECS

CLEAR FLOOR CEILING HEIGHTS

**3.9M** SLAB TO SLAB  **2.8M** FLOOR TO CEILING

DEDICATED  
SHOWERS WITH  
CHANGING &  
DRYING FACILITIES

**BREEAM®**  
★★★★  
Excellent



## AREA SPECIFICATION

FLOOR LEVEL	NET INTERNAL AREA (SQ FT)
Ground Floor	6,190
	Unit 1 — 1,787
	Unit 2 — 4,403
1st Floor	15,285
2nd Floor	16,975
3rd Floor	16,975
4th Floor	16,975
5th Floor	16,975
6th Floor	16,975
7th Floor	16,975
8th Floor	12,260
9th Floor	12,433
10th Floor	7,115
<b>TOTAL</b>	<b>155,133</b>

# STORY

# PAPER



Belfast has long been famous for the craftsmanship of its manufacturing industries. Linen, rope and paper left these shores to be sold worldwide, shaping the architecture of the city in the process.

Paper warehouses rose on Chichester Street and Gloucester Street, receiving stock from the mill on Joy Street before they were sent to the port. Papermakers paid close attention to their craft, rotating each leaf to create fine-grained surfaces for a wide variety of uses - from newsprint to artwork. The embodiment of this craft and skill was known as 'the paper exchange'.

**THE  
PAPER  
EXCHANGE**



**THE EMBODIMENT  
OF SKILL AND CRAFT**



# WHERE GOOD THINGS ALIGN

Centrally situated and designed for visionary businesses. The Paper Exchange will set a new, state-of-the-art standard for Northern Ireland development.

This is a world-class space. A building bound to the city's paper creating history, it is a contemporary canvas for bright, bold-thinking businesses. The Paper Exchange is rich with character, thoughtful design details and impactful spaces. This is a place where good things align.

# WHERE

# LOCATION

Belfast is a global city situated in the UK, with direct routes to Europe and within easy reach of all major centres.

**BELFAST IS 4TH GLOBALLY FOR CONNECTIVITY AMONGST SMALL AND MID-SIZED CITIES**

Source: [belfastcity.gov.uk/business/investinginbelfast](http://belfastcity.gov.uk/business/investinginbelfast)

**3 AIRPORTS**

Regular direct flights to the UK, Europe, Asia and North America.

**90 MINS**

By road or rail from Belfast to Dublin, the capital of the Republic of Ireland.

**IDEALLY SITUATED BETWEEN MAINLAND EUROPE & THE US**

**4 PORTS**

Belfast Harbour, Larne Harbour, Foyle Port and Warrenpoint Harbour.

**COMPETITIVE NEAR-SHORE POSITION TO EUROPE**

The only part of the UK that shares a land border with the EU (Republic of Ireland).



● PLANE  
○ CAR



AT THE HEART  
OF THE CITY

THE  
PAPER  
EXCHANGE

AT THE HEART

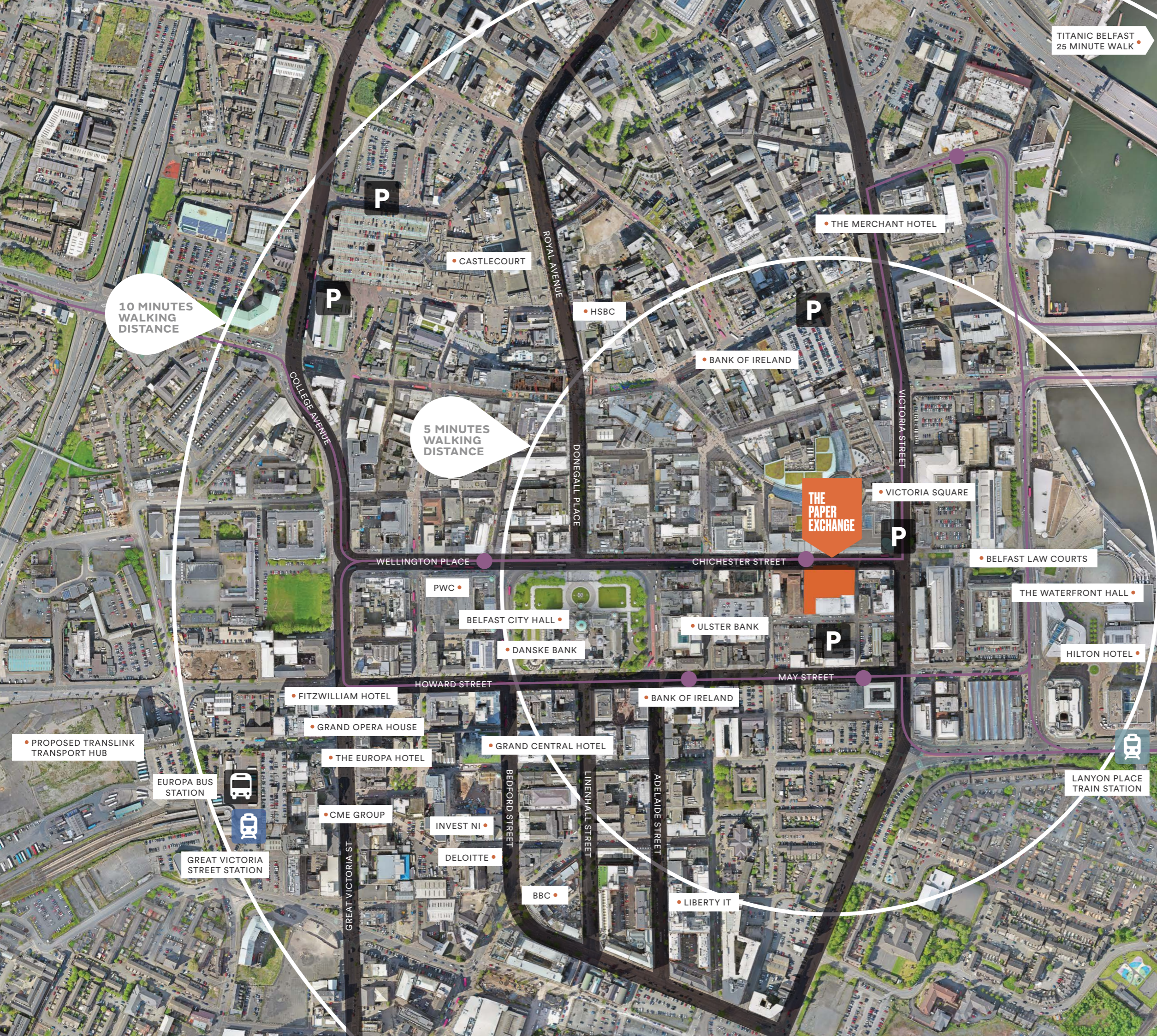

TRAVEL DISTANCES TO TRANSPORT AS FOLLOWS:



**BUS**

**Europa Bus Station**

Walk - 10 mins

Glider Route

Glider Stops



**TRAIN**

**Belfast Lanyon Place**

Railway station (trains to Dublin and local routes)

Walk - 5 mins

**Belfast Great Victoria Street**

Railway Station

Walk - 10 mins



**AIRPORT**

**George Best Belfast City Airport**

Car - 10 mins

**Belfast International Airport**

Car - 25 mins

**Dublin Airport**

Car/Bus - 1 Hour 30 mins



THE  
PAPER  
EXCHANGE

# SURR- OUNDS



## A LANDMARK BUSINESS SPACE FOR NORTHERN IRELAND

Prominently placed in the heart of Belfast's central business district, The Paper Exchange is surrounded by a multitude of food, cultural and commercial destinations – this is a landmark business space for Northern Ireland.



# LIFE IN BELFAST

Belfast boasts all the amenities a global city has to offer, with all of the benefits of a unique provincial capital. You'll find great shopping, with your favourite high street shops and fascinating local boutiques. There's a calendar full of local festivals and fun cultural events to enjoy. And then of course, there's the food.



# EAT



STORY | SURROUNDS | SPACE



For a small city, Belfast is simply bursting with great places to eat. You'll find venerable old establishments that have been serving hearty local fare for centuries, and chic new eateries serving up the latest gastronomic trends. Food trucks pull up on city corners, ready to satisfy lunch time appetites. You'll never be at a loss for somewhere to entertain clients and colleagues. There's a host of brilliant bars and pubs - from the historic white-washed walls of Kelly's Cellar to the exuberant rooftop bar at The Perch.

**THE  
PAPER  
EXCHANGE**

# EAT



the pocket

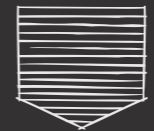

The National

YU  
GO



Images, clockwise from top left. Previous page: Bullitt Hotel (3), The Cloth Ear, The National (2). This page: Coppi (2), Bullitt Hotel, The Pocket Flatiron Coffee Shop (2), Yugo Restaurant.



STORY | SURROUNDS | SPACE



# STAY



STORY | SURROUNDS | SPACE



Belfast's high-class hotels are perfect for hosting visitors from all over the world. There's the iconic Merchant Hotel, with its sumptuous, high Victorian architecture; the Titanic Hotel, celebrating the Golden Age of Ocean Travel; the contemporary beauty of the Belfast Marriot; and the opulence of The Grand Central.

Your downtime is precious. Thankfully, Belfast is full of ways to spend it well. Explore the fascinating art, history and science collections at the Ulster Museum. Take in a show at the Grand Opera House. See the action of a rugby match at Kingspan Stadium.

Explore cultural attractions like Titanic Belfast, a fascinating exploration of the ill-fated ship and the people who built her. Take in some fresh air at Belfast's gorgeous Botanic Gardens, the moorlands of Cave Hill, Divis or the Black Mountain. Set out for an adventure along the epic North Coast and the Causeway Coastal Route. You'll never be stuck for something to do.



# STAY



THE *fitzwilliam* HOTEL  
belfast



TITANIC HOTEL  
BELFAST

Images, clockwise from top left. Previous page: The Fitzwilliam (2), The Grand Central, Titanic Belfast, The Merchant. This page: The Fitzwilliam, Botanic Gardens, Victoria Square, The Titanic Hotel (2).



# BUSINESS ARENA



Source:  
Invest NI unless stated.

OVER  
**900**  
INTERNATIONAL  
COMPANIES

EMPLOY AROUND 100K PEOPLE  
IN NORTHERN IRELAND.



**#1 IN EUROPE &  
#2 WORLDWIDE  
FOR FDI STRATEGY**

Source:  
FDI Magazine Global Cities of the Future 2018/2019



**OPERATING  
COSTS AVERAGE  
12%–30% LOWER  
THAN THE REST  
OF THE UK  
AND EUROPE**

**BELFAST IS THE  
WORLD'S MOST  
BUSINESS-FRIENDLY  
CITY OF ITS SIZE**

**WORLD-CLASS  
CLUSTERS IN  
A VARIETY OF  
SECTORS**

Technology and Financial  
Professional Services sectors are  
experiencing the fastest growth  
in the UK.

**A STRONG  
TRACK RECORD**

in the aerospace, advanced  
engineering, manufacturing,  
and life and health sciences sectors.

**75%**

of investors reinvest in NI.

# TALENT

# 2 WORLD-CLASS UNIVERSITIES

QUEEN'S UNIVERSITY (RUSSELL GROUP)  
ULSTER UNIVERSITY

# OVER 15,000 STUDENTS

graduate from business-related degrees on the island of Ireland each year.

Northern Ireland is home to a network of further education colleges providing excellent academic and vocational training.



## GLOBALLY RECOGNISED RESEARCH CENTRES

across a range of disciplines. Each have a strong track record in commercialisation of research.

Source:  
Invest NI unless stated.

## NORTHERN IRELAND HAS THE BEST PERFORMING EDUCATION SYSTEM

FOR PRIMARY MATHS IN EUROPE, AND THE SIXTH BEST IN THE WORLD

“The supply of talent in Northern Ireland, particularly at graduate level, is impressive... it makes this region highly attractive to a global company seeking the best location for growth”.

James Bardrick, Citi CEO Global Markets  
Source: Think NI – Invest NI

## THE LEGAL TALENT POOL

includes an annual surplus of some 500 law graduates as well as an experienced network of professionals who are keen to return and relocate to the region.

## QUEEN'S UNIVERSITY IS THE UK'S LEADING UNIVERSITY FOR INTELLECTUAL PROPERTY COMMERCIALISATION

# ONE OF THE YOUNGEST POPULATIONS IN EUROPE

## WITH 55% UNDER THE AGE OF FORTY



# TECH, FINANCE & PROFESSIONAL SERVICES

## A HUB FOR LEGAL TECHNOLOGY AND INNOVATION

Globally renowned as a magnet for mobile fintech investment, home to one of the fastest-growing technology clusters and a host of leading international law firms.



Source:  
Invest NI unless stated.

## BELFAST IS NOW THE NUMBER ONE DESTINATION



for financial technology  
investments in the world.

## BELFAST IS EUROPE'S LEADING LOCATION FOR NEW SOFTWARE DEVELOPMENT PROJECTS

## Belfast is one of FT FDI Intelligence's TOP 10 DIGITAL ECONOMIES OF THE FUTURE

Source:  
FDI Magazine Global Cities of the Future 2018/2019

# 70%

OF IT AND TELECOMS  
PROFESSIONALS HOLD  
A HIGHER EDUCATION  
QUALIFICATION

## BEST AREA IN THE U.K. FOR SUPERFAST BROADBAND AVAILABILITY.

AVAILABILITY AND 4G DOWNLOAD  
SPEEDS – TELECOMS COSTS AMONGST  
THE LOWEST IN EUROPE.





# SPACE

THE  
PAPER  
EXCHANGE

The prioritising of good design and uncompromising quality of build will be evident from every angle, on every level. This will be a wholly unique space for the progressive, future-focused occupier.

# GOOD

**GOOD DESIGN AND  
UNCOMPROMISING  
QUALITY**



THE  
PAPER  
EXCHANGE

- 10 Tenants
- 9 Tenants
- 8 Tenants
- 7 Tenants
- 6 Tenants
- 5 Tenants
- 4 Tenants
- 3 Tenants
- 2 Tenants
- 1 Tenants









**EFFICIENT AND  
FLEXIBLE FLOOR  
PLATES FOR  
A MULTITUDE  
OF LETTING  
OPTIONS**

# AREA SPECIFICATION

FLOOR LEVEL	NET INTERNAL AREA (SQ FT)
Ground Floor	6,190
	Unit 1 — 1,787
	Unit 2 — 4,403
1st Floor	15,285
2nd Floor	16,975
3rd Floor	16,975
4th Floor	16,975
5th Floor	16,975
6th Floor	16,975
7th Floor	16,975
8th Floor	12,260
9th Floor	12,433
10th Floor	7,115
<b>TOTAL</b>	<b>155,133</b>

# SUMMARY SPECIFICATION

**155,133** SQ FT LANDMARK BUILDING | **11** STOREY | **DOUBLE HEIGHT ENTRANCE LOBBY**

**GRADE A**  
OFFICE SPECIFICATION

FLOORPLATES FROM  
**7,115 SQ FT**  
TO  
**16,975 SQ FT**

**4,000 SQ FT**  
PRIVATE TERRACE ON 8TH FLOOR

**7 LIFTS**  
6 x 17 PASSENGER & 1 GOODS LIFT



AVERAGE LIFT WAITING TIME < 25 SECS

CLEAR FLOOR CEILING HEIGHTS

**3.9M** SLAB TO SLAB | **2.8M** FLOOR TO CEILING



**85**  
BICYCLE SPACES



**15**  
CAR SPACES



DEDICATED SHOWERS WITH CHANGING & DRYING FACILITIES



FULLY AIR CONDITIONED



CARPETED RAISED ACCESS FLOORS

ESSENTIAL SERVICES STANDBY GENERATOR

**1:8** BASE (PERSON/SQM)  
**OCCUPANCY**

**7.5M x 8M**  
PLANNING GRID

# GROUND FLOOR

**NET AREA: 6,190 SQ FT**

Unit 1 – 1,787 sq ft

Unit 2 – 4,403 sq ft

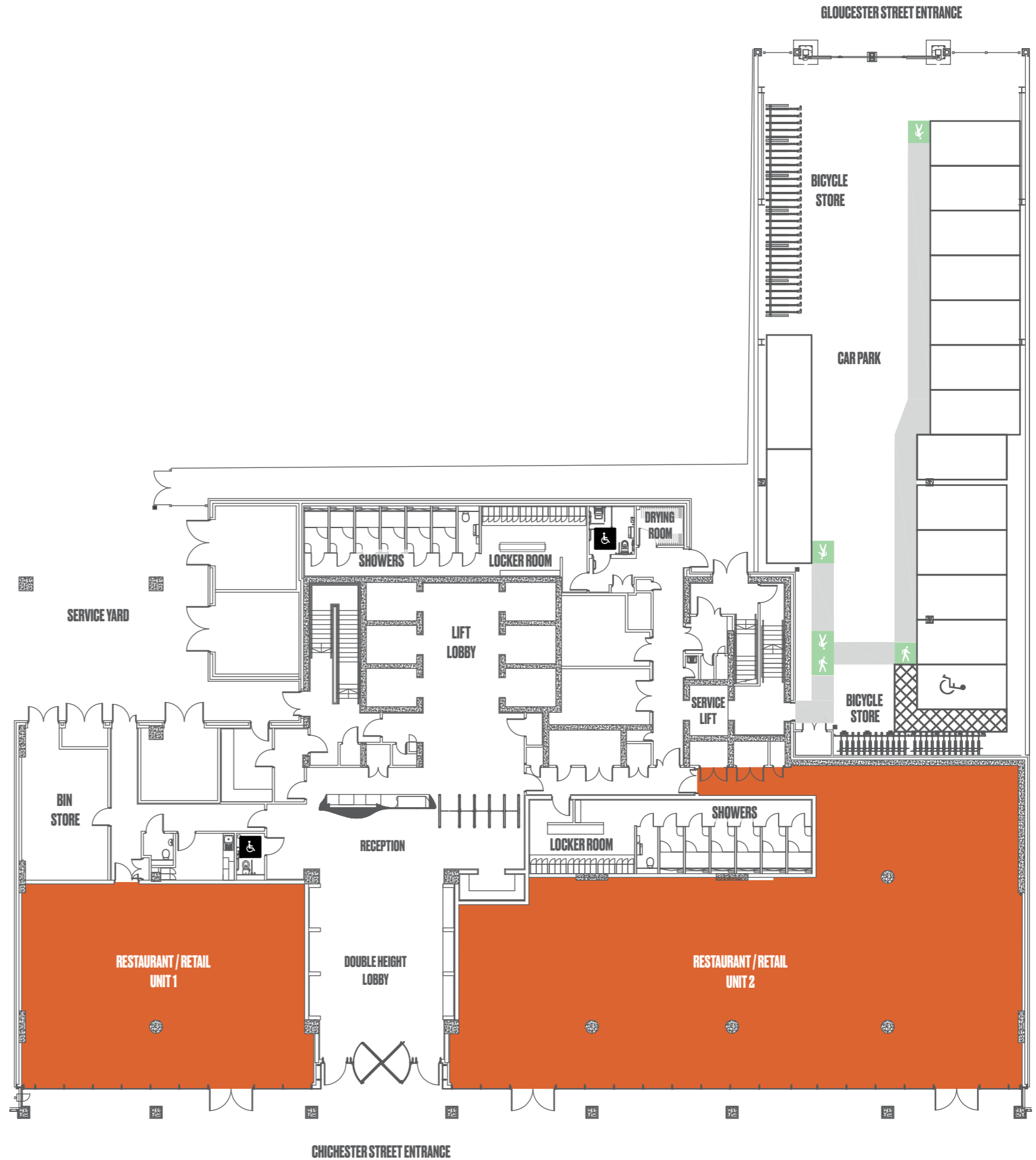
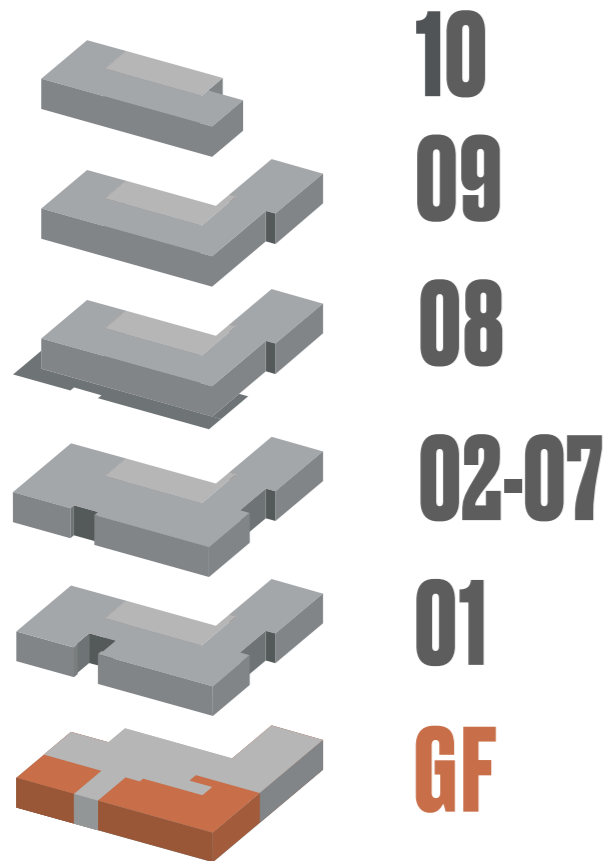

# FIRST FLOOR

NET AREA: 15,285 SQ FT

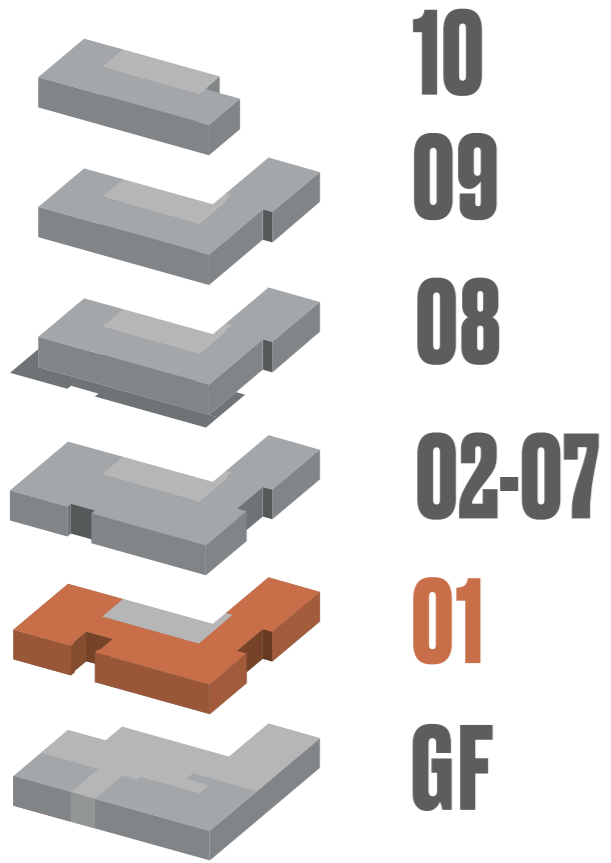

# SECOND TO SEVENTH FLOOR

NET AREA: 16,975 SQ FT

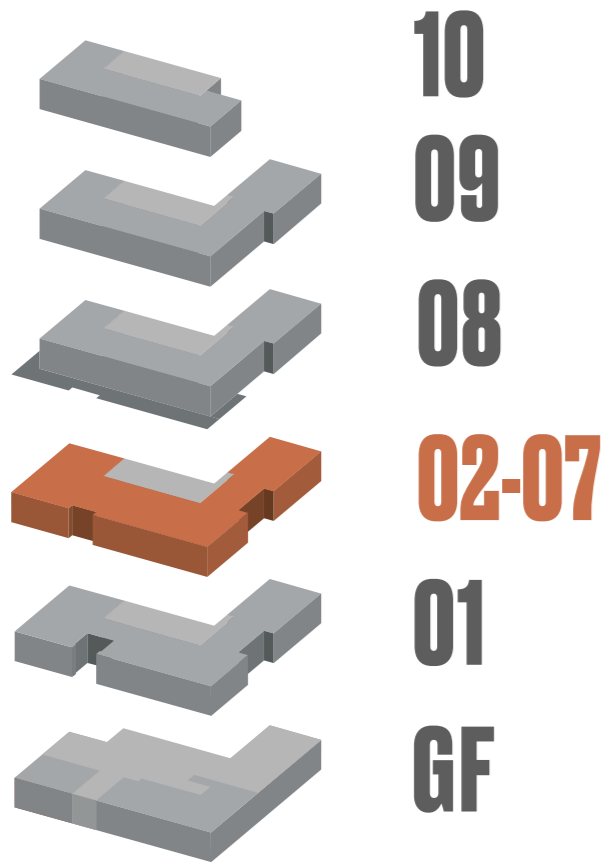

# EIGHTH FLOOR

NET AREA: 12,260 SQ FT

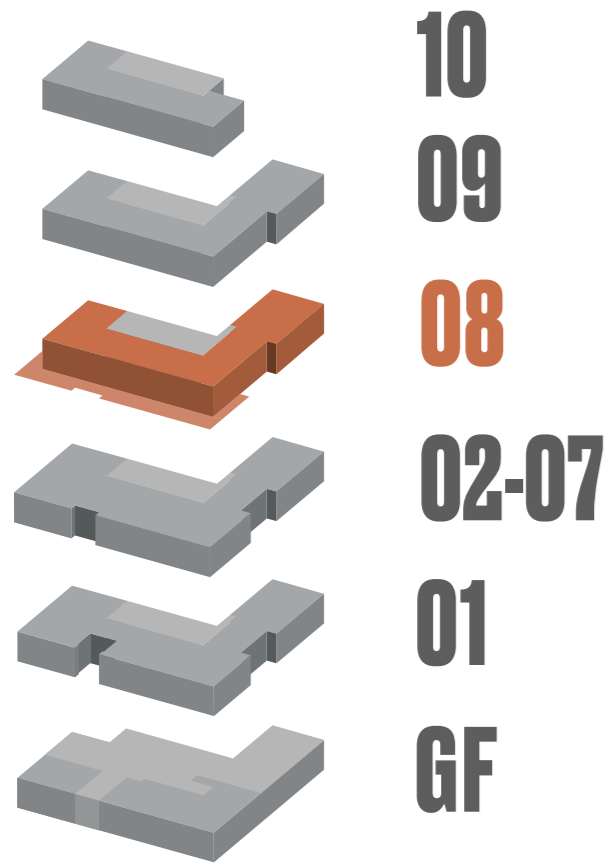

# NINTH FLOOR

NET AREA: 12,433 SQ FT

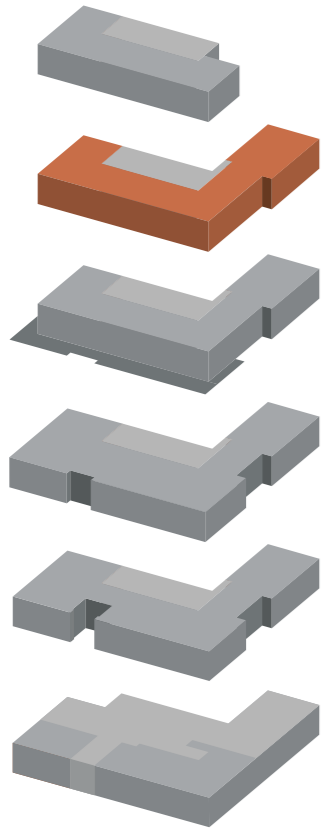

10  
09  
08  
02-07  
01  
GF





# TENTH FLOOR

NET AREA: 7,115 SQ FT

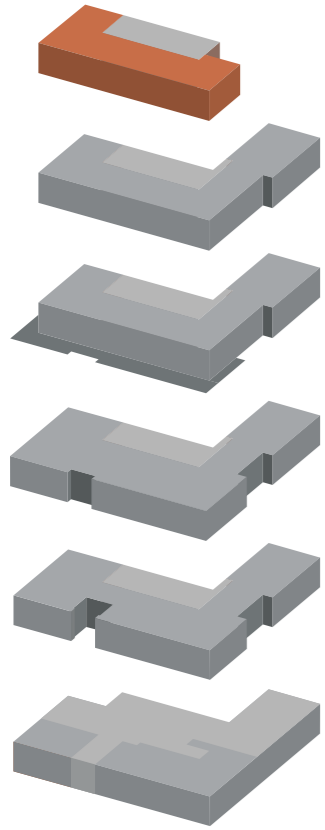

**10**  
**09**  
**08**  
**02-07**  
**01**  
**GF**

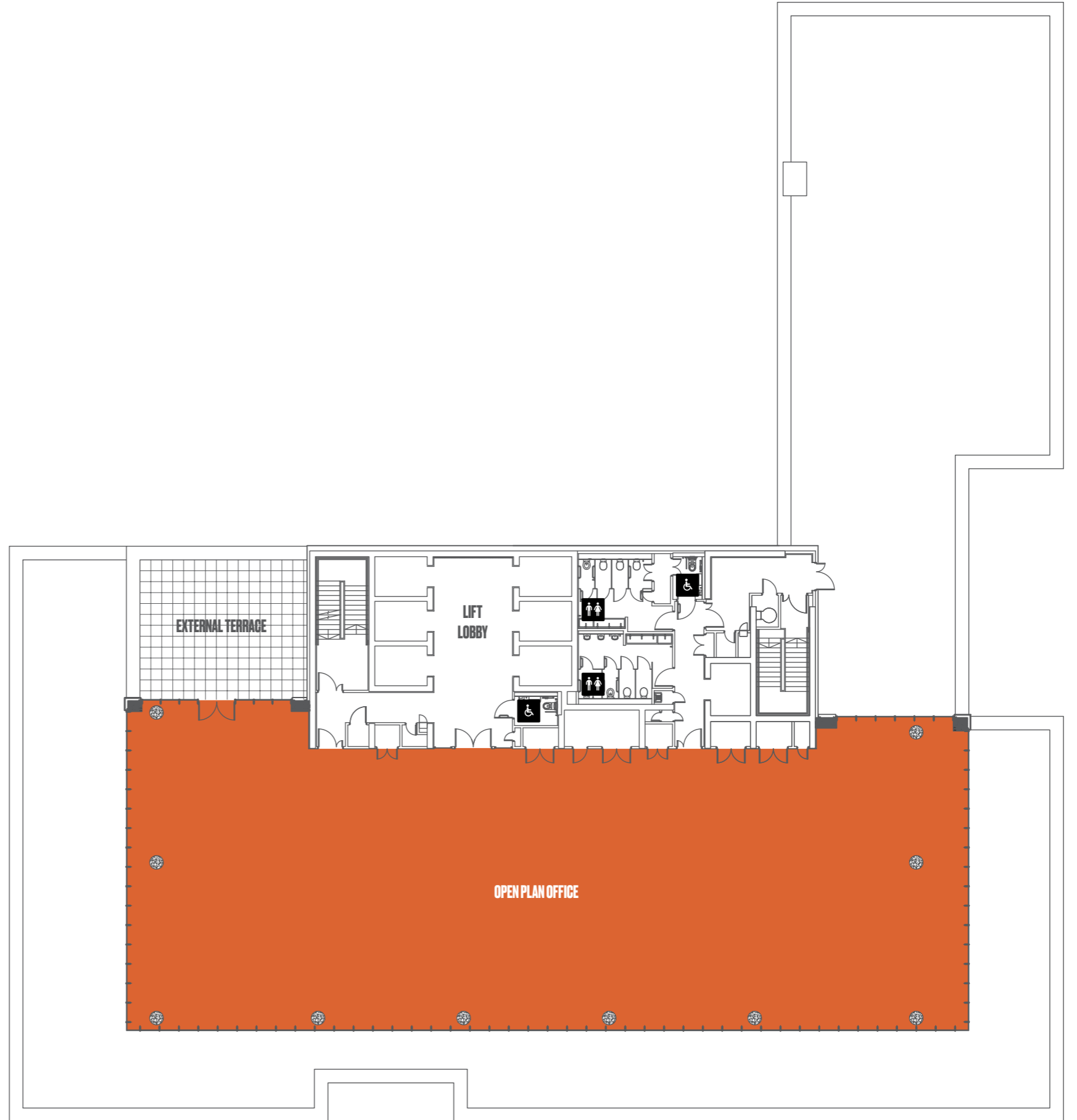

TYPICAL FLOOR PLAN

# FINANCIAL SERVICES

1:8 Ratio

NET AREA: 16,975 SQ FT

Capacity details per typical floor plan:

Desks	196
Private Office	2
Meeting Rooms	3
Communal Tables	5
Kitchen Area	1
Break Out Area	2
Sofa	2

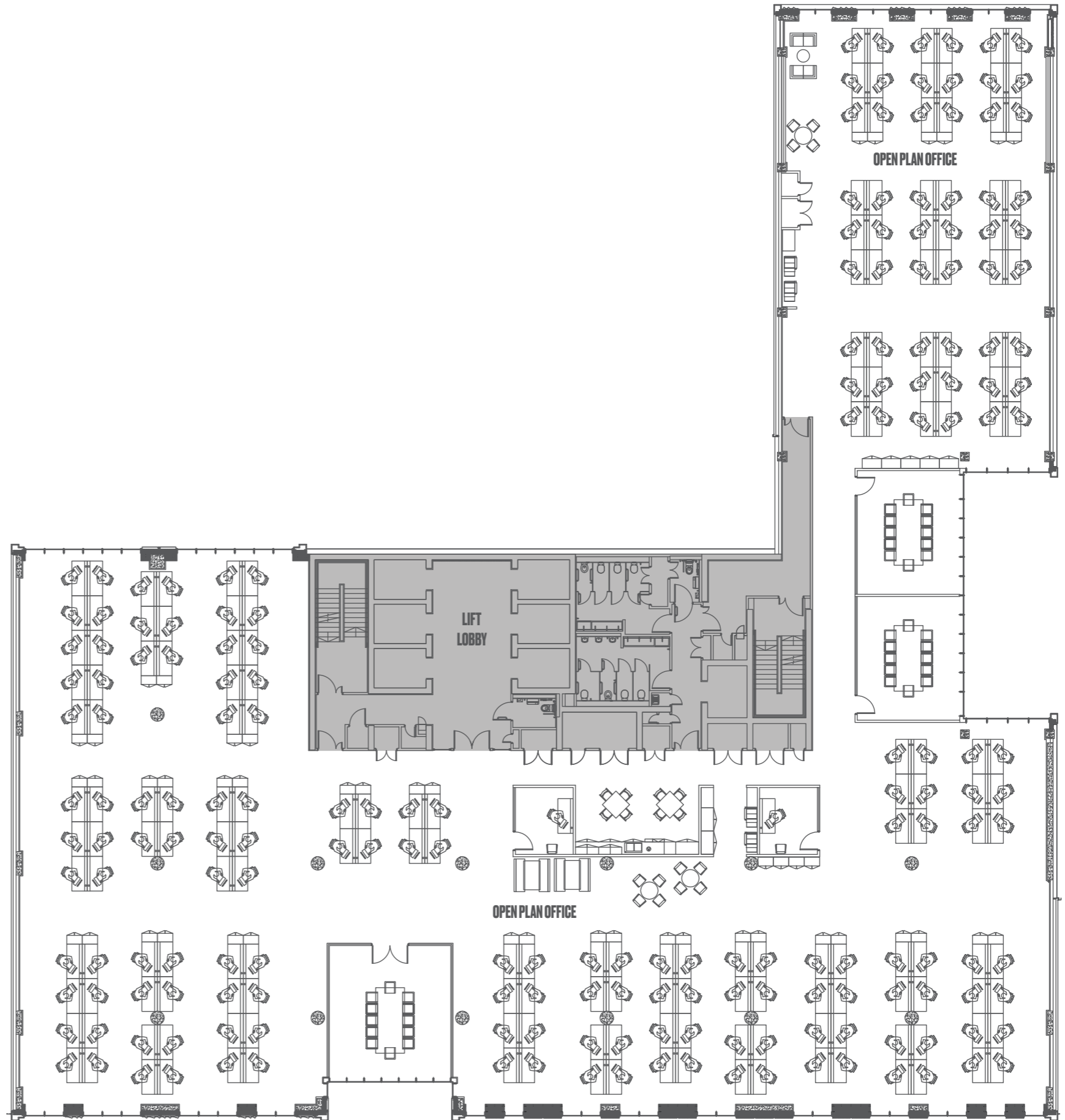
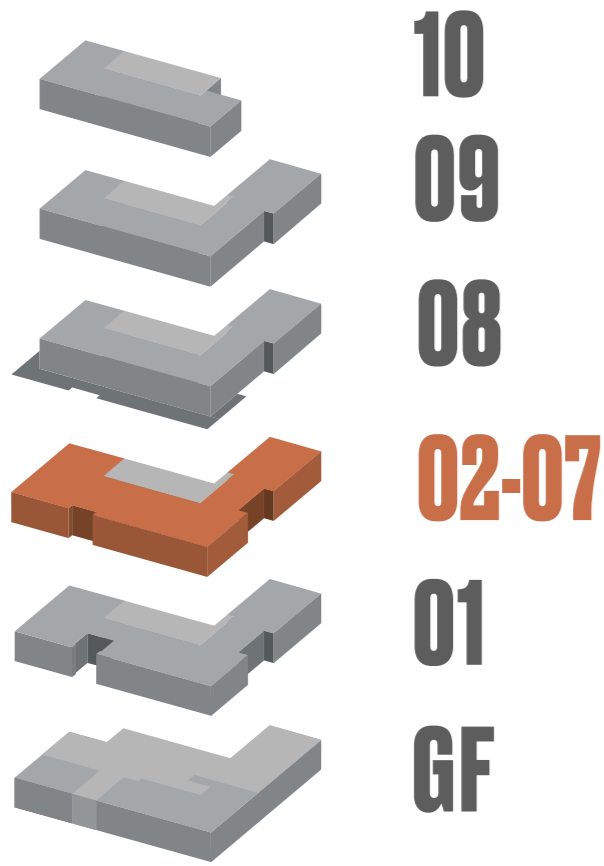

TYPICAL FLOOR PLAN

# TECHNOLOGY / FINANCIAL SERVICES

1:10 Ratio

NET AREA: 16,975 SQ FT

Capacity details per typical floor plan:

Desks	156
Private Office	2
Meeting Rooms	3
Communal Tables	6
Kitchen Area	1
Break Out Area	3
Sofa	2

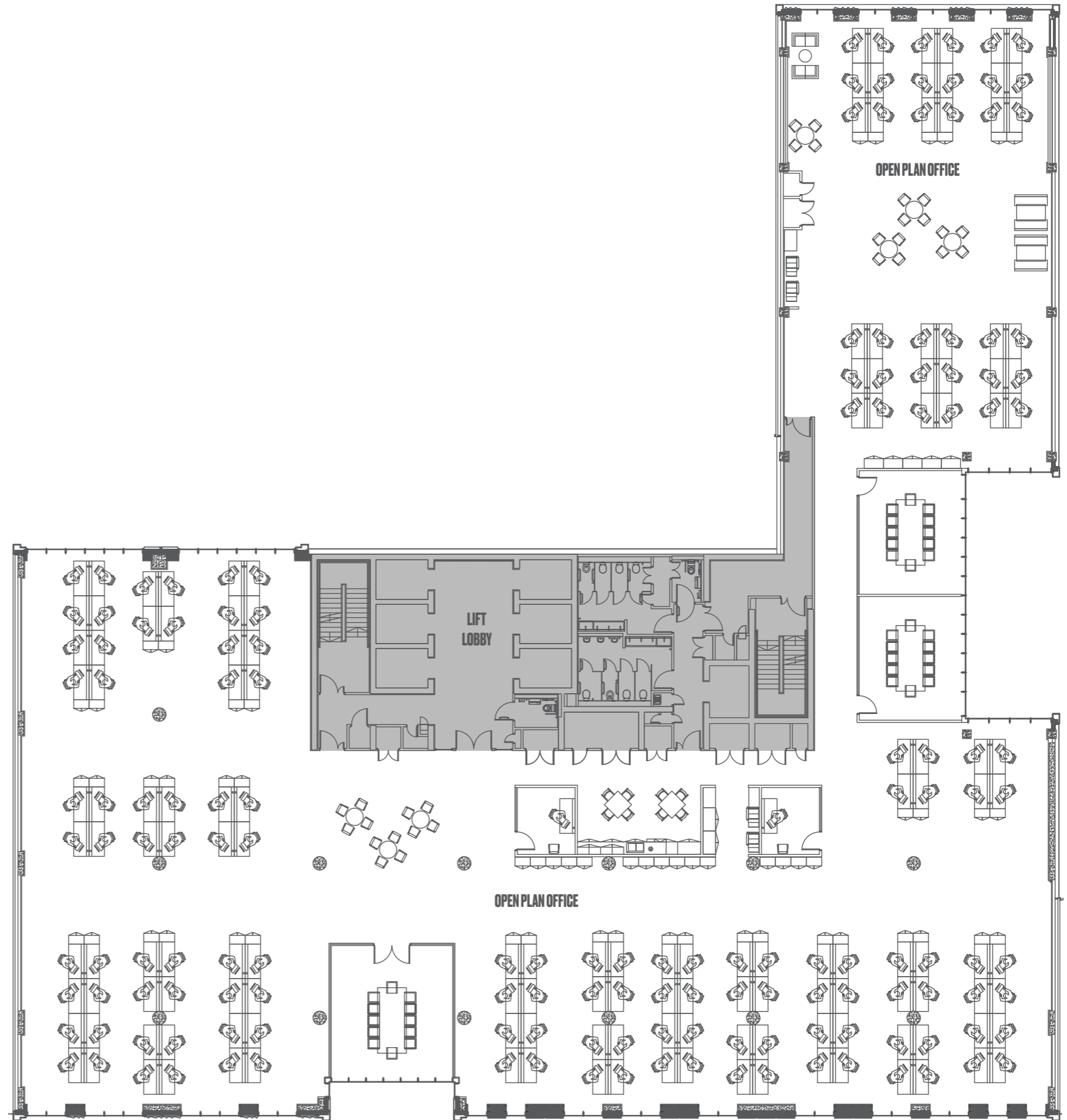
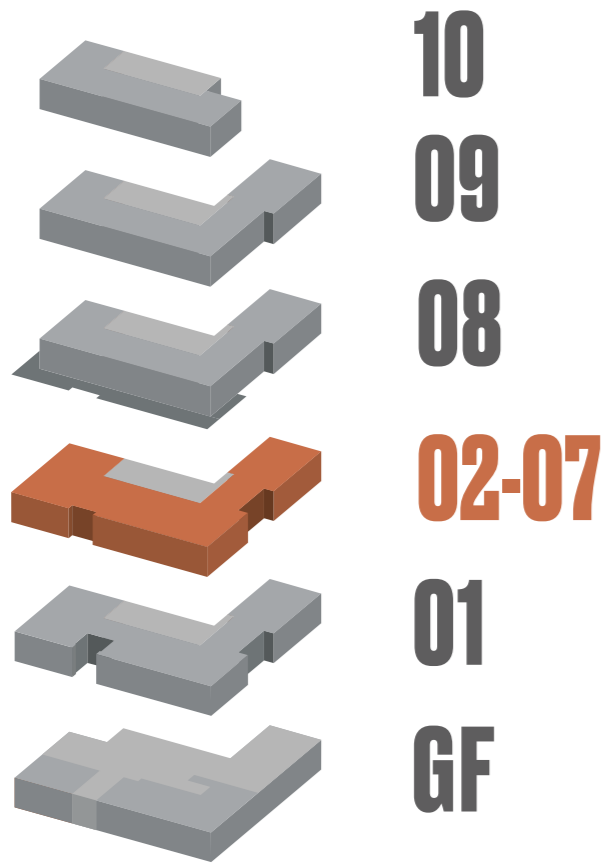

TYPICAL FLOOR PLAN

# PROFESSIONAL SERVICES

1:12 Ratio

NET AREA: 16,975 SQ FT

Capacity details per typical floor plan:

Desks	128
Private Office	4
Meeting Rooms	3
Communal Tables	15
Kitchen Area	1
Break Out Area	5
Sofa	2

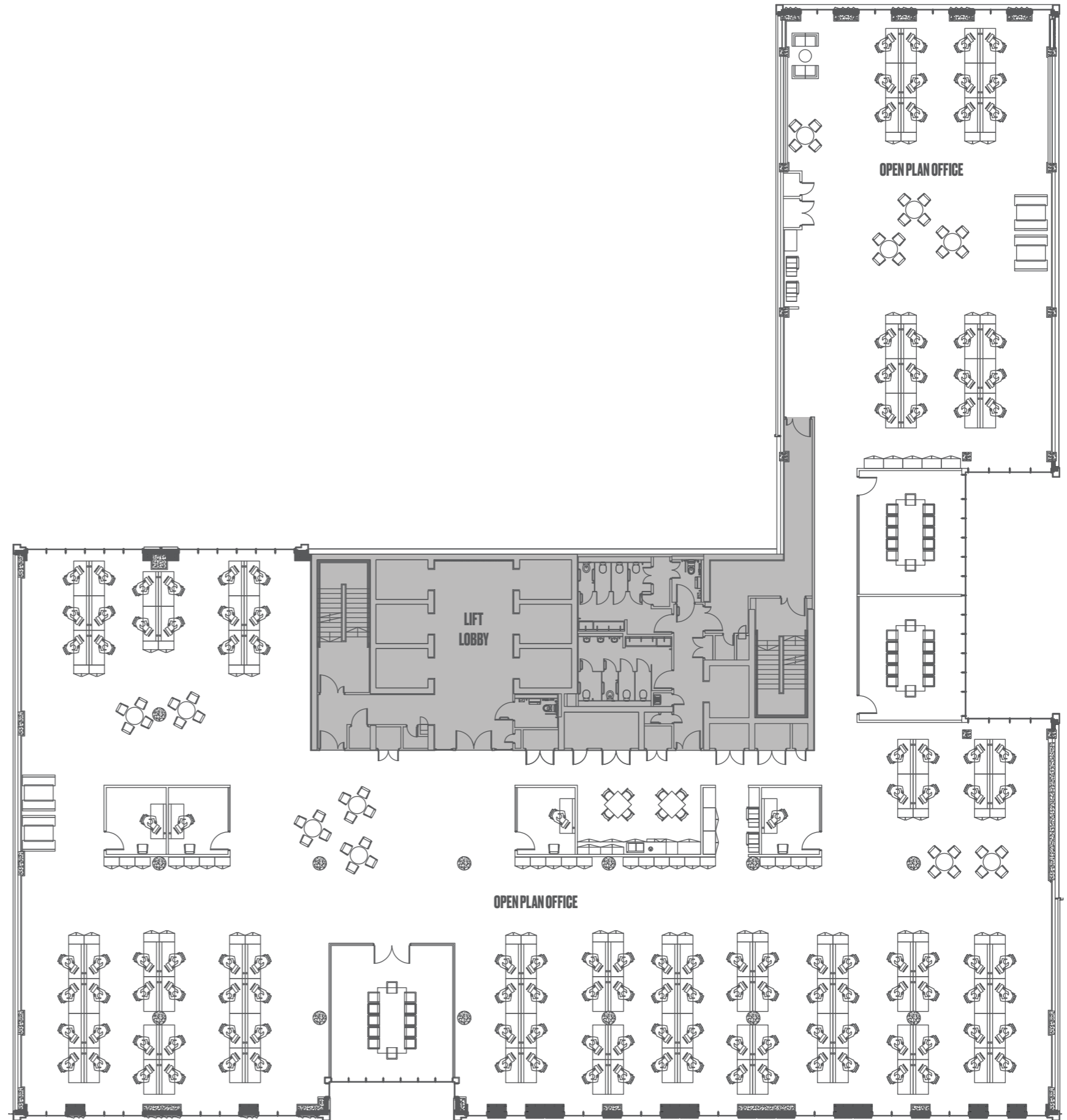
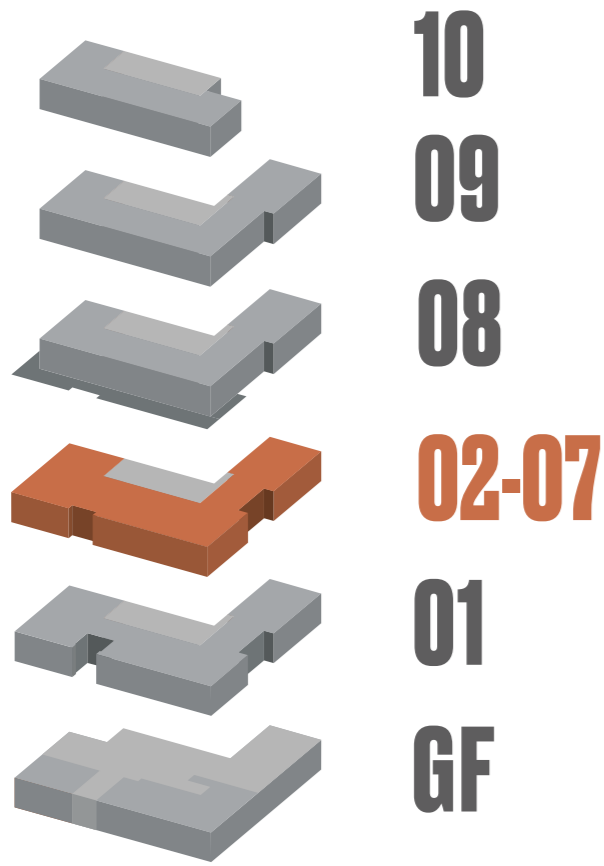



# FACILITIES



## TOILETS

### FULL HEIGHT CUBICLES

in black oak finish with brush gold ironmongery

### OVERHEAD MIRROR SYSTEM

with built in hand dryer, foam dispenser

---



## SHOWER

### PORCELAIN

wall and floor tiles

### BRUSHED GOLD

fittings

### PRIVATE

changing area within cubicles

---



## LOCKER ROOM

### LARGE WALL MIRRORS

and dedicated vanity area

### INTEGRATED LOCKER

system with mixed sizing

### DRYING ROOM

situated in adjacent room

---





# IN-DEPTH SPECIFICATION

## TECHNICAL SPECIFICATION

### STRUCTURE AND EXTERNAL FINISHES

#### SUBSTRUCTURES

- Suspended reinforced concrete ground slab with integral pile caps and ground beams
- Piled foundations (CFA)

#### STRUCTURE

- In situ reinforced concrete frame including smooth circular concrete columns
- In situ reinforced concrete flat slab structure to floors 1 to 8
- Composite steel frame to south wing of floors 1 to 8 and throughout floors 9 and 10
- 150 mm thick prestressed plate floor units act compositely with steel floor beams to provide 14 m clear spans
- Beam webs perforated with service holes to provide horizontal services distribution within structural depth
- 300 mm flat slab in situ concrete floor slabs designed to provide a minimum of 4.00 kN/m<sup>2</sup> occupancy load
- Precast concrete stairs and landings
- In situ reinforced concrete walls to stairwells and lift core areas

#### EXTERNAL WALLS

- Natural stone colonnade with contrasting stone plinth, framing the ground floor entrances
- Solid, perforated and profiled aluminium panels with PPC Powdertech, Evolution Scorched Earth finish, glazed into the curtain walling system and as a rainscreen system
- Horizontal aluminium feature fins with the same Scorched Earth finish
- Facing brick with contrasting brick plinth at ground floor level to the inner courtyard area on the southern side of the building and boundary to the western side of the building
- Above ground floor level, glazed areas and aluminium rainscreen cladding finished to match all other cladding
- Insulated Sto Render to all other areas
- Structurally glazed, double glazed aluminium curtain walling system with fritted glass zone
- Capped curtain wall system with double glazed glass units to floors 8, 9 and 10, wrapping around the floor plates and finishing at the core
- All glazing systems are full height clear glass with thermal insulation, solar control and acoustic attenuation to achieve high environmental standards
- Four leaf glazed revolving door

#### ROOF FINISHES

- Paving on high performance bitumen membrane forming an inverted roofing system to roof terrace areas of floors 8 and 9
- Planting and incorporated seating areas on floor 8 roof terrace
- High performance, built-up, reinforced bitumen warm deck roofing system on insulation, screed & concrete slab to the main roof
- All parapets are PPC aluminium to match cladding
- Full stair access to roof

- Roof fall-arrest system allowing safe access to main roof areas for maintenance
- Abseiling system with concealed sockets allowing access for cleaning of glazing system
- Louvred plant enclosure with louvred access doors

#### SITWORKS & DRAINAGE

- Basalt paving to main entrance footway below colonnade
- Access control to car park, all main entrance doors and access points
- Secure car parking area with direct access from Gloucester Street
- Secure covered cycle parking area with direct access from Gloucester Street

### INTERNAL FINISHES

#### OFFICE FLOOR FINISHES

- Proprietary fully removable and interchangeable steel encapsulated chipboard core raised access floor panels to all office areas
- Promat or similar fire barriers to floor voids and ceiling voids

#### OFFICE CEILING FINISHES

- Microperforated metal ceiling tiles with acoustic fleece and OP19 acoustic pad or equivalent for enhanced acoustic performance
- Perimeter plasterboard bulkheads to perimeter

#### JOINERY TO OFFICE AREAS

- Solid doors with brushed gold ironmongery, fire rated as necessary
- Concealed riser access doors finished to match adjacent wall finish
- Brushed gold/brass ironmongery
- All stair and lobby core doors allow for hidden wiring for access control

#### ENTRANCE LOBBY FINISH

- Floor porcelain tiles with feature brushed gold/brass trim at each joint
- Feature timber glulam framing to double height space with timber batten wall, integrated table and seating arrangement
- Feature wall finished with porcelain tiles. All other walls polished concrete plaster finish
- Feature reception desk with American White Oak profiled fins
- Aluminium cladding panels to lifts with contrasting aluminium perforated overhead panels with black acoustic fleece
- Casoline MF type plasterboard ceiling system with painted skimmed plasterboard finish
- Feature strip lighting to plasterboard ceiling and lift lobby walls
- Lifts to have internal side walls in premium metal finish with rear panels fully glazed mirror finish and porcelain tiles on lift floors

#### MAIN UPPER LIFT LOBBY FINISHES

- Floor porcelain tiles
- Feature timber batten wall
- Polished concrete plaster wall finish
- Aluminium cladding panels to lifts with contrasting aluminium perforated overhead panels with black acoustic fleece
- Casoline MF type plasterboard ceiling system with painted skimmed plasterboard finish
- Feature strip lighting to plasterboard ceiling and lift lobby walls

#### STAIR FINISHES

- American White Oak handrails with PPC mild steel balustrade, PPC mild steel plate stringer to both stairs
- Norament rubber pre-shaped stair covering with contrasting inserts in treads and contrasting nosing colour to treads and risers
- Feature inlay as floor designation in floor finish

#### TOILET FITTINGS & FINISHES

- Wall-hung WC with concealed cisterns
- Solid surface trough wash basin with removable access panels
- Full height toilet cubicles with brushed gold/brass ironmongery
- Overhead mirror system with built in hand dryer and foam dispenser
- 600 mm x 600 mm R11 porcelain floor tiles
- 300 mm x 600 mm x 10 mm porcelain wall tiles
- MF type plasterboard ceiling systems with concealed access panels to all services above
- Feature bulkheads and concealed lighting detail to ceiling

#### SHOWER AREA FITTINGS AND FINISHES

- Brushed gold matt finish shower head
- Overhead mirror system with built in hand dryer and foam dispenser
- 600 mm x 600 mm R11 porcelain floor tiles
- 300 mm x 600 mm x 10 mm porcelain wall tiles
- MF type plasterboard ceiling systems with concealed access panels to all services above
- Recessed compact LED downlights

## MECHANICAL SPECIFICATION

### DESIGN CRITERIA

#### EXTERNAL DESIGN CRITERIA

##### SUMMER

Fresh Air Temperature: 30°C (db), 22°C (wb)

Maximum Air Temperature for Cooling plant: 35°C (db)

##### WINTER

Fresh Air Temperature: -5°C (db), -5°C (wb)

#### INTERNAL DESIGN CRITERIA

Area/Room	Min Winter Temperature °C	Max Summer Temperature °C	Control	RH %	Reference
General Corridors	19	25	Local Control	Not controlled	CIBSE Guide A
Toilet areas	19	25	Local Control	Not controlled	CIBSE Guide A
Stores	15	-	Local control	Not controlled	CIBSE Guide A
Offices	22	24	Local control	Not controlled	CIBSE Guide A
HVAC Rooms	10	-	Local control	Not controlled	

#### FRESH AIR CRITERIA

Parameter	Minimum Ventilation Rate	Reference
Offices	12 l/s/person (based on 1 person / 8m <sup>2</sup> )	BREEAM 2014 Building Regulations Part K = 12l/s (Includes 10% spare capacity)
Toilets	7 ACH	In accordance with CIBSE Guide A

#### COOLING LOAD

Parameter	Cooling load allowance W/m <sup>2</sup>
Offices	90

#### BACKGROUND NOISE LEVELS

Area	NR
Open Plan Office	40
Offices	35
Toilets	40
Plant Areas	65
External Criteria	57

## DETAILED SPECIFICATION

### AIR QUALITY

- Rooms with “bad air” (gaseous and particulate pollutants), such as toilets, shall be put under negative pressure towards surrounding room spaces, i.e. more exhaust air than supply air
- Exhaust air discharge points shall be placed at high location or roof level
- Fresh air shall be balanced in conjunction with re-circulated, exhaust filtered and conditioned air
- Outdoor air intakes shall be installed in positions such that the air cannot be polluted by discharge air, sanitary vents or exhaust from standby generator (diesel)

### OPERATING PERIODS

- The building will be operational on 24 hour / 7 days a week basis
- The office areas shall be assumed to operate on a 12-hour day with extended operation on a floor by floor basis achievable through the Building Management System (BMS)
- Facility for computer and individual hub rooms to operate with 24-hour cooling. These services will be provided as part of a tenant fit-out

# IN-DEPTH SPECIFICATION

## HEATING SYSTEM

- Space heating to the landlord areas will be provided with a combination of underfloor heating and wall mounted radiators. Each space will have temperature control
- Space heating to the office floors, lift lobbies and entrance area will be provided by variable refrigerant flow (VRF) fan coil units
- Each heating circuit will include two variable speed drive circulation pumps arranged in a duty/standby configuration. SMART energy meters will be installed on each heating circuit and to the domestic hot water calorifier
- The low temperature hot water (LTHW) supply to the landlord area will be provided by high efficiency gas fired boilers. These will be connected to low loss header arrangement, which will generally serve the following constant or variable and constant temperature LTHW heating circuits:
  - Space Heating radiators within the core (Variable Temperature 80°C/60°C)
  - Space Heating underfloor within the core (Variable Temperature 80°C/60°C)
  - Domestic Hot Water generation (Constant Temperature 80°C/60°C)
- An over-door air curtain will also be provided at the main entrance to the building
- All control systems associated with the boiler installation will be interfaced with the BMS

## AIR-CONDITIONING SYSTEM

- The provision of comfort cooling will only be provided to serve areas where natural and/or mechanical ventilation alone will not maintain the internal air temperature, with set design parameters to minimise energy consumption
- All office areas within the tenant demise and reception area will be provided with comfort cooling
- Comfort cooling to these areas will be derived by a VRF R32 refrigerant based comfort cooling system
- These systems will generally consist of a central bank of high coefficient of performance (COP) external condensing units matched to the required system cooling load. Condensing unit compressors will be frequency inverter controlled to maximise system efficiency under part load conditions. The system will be designed to achieve a minimum COP of 5 to 1 based on external design conditions for the site. Condensing units will be located externally away from view of the public
- All system components associated with the cooling installation will be interfaced with the BMS. The indoor units will have local simplified control to provide the user with a degree of system control with set parameters. All plant and control devices will be suitable for systems integration utilising Open Protocol Communication (OPC)

## WATER SERVICES

- Potable water shall be available to each floor
- All urinal cisterns shall incorporate a flow saving device
- WC cisterns shall have a maximum flushing capacity of 6 litres

## FIRE FIGHTING

- Firefighting will be provided in accordance with building regulation requirements

## SANITARY

- The soils and waste installation shall be in lead free uPVC

## SPRINKLER SYSTEM

- A sprinkler system will be provided to the building. The sprinkler tank will be located within the mezzanine level of the ground floor car park. This will have diesel and electric powered pumps

## AUTOMATIC CONTROL SYSTEMS

- A BMS will be provided to control and monitor the building's energy, air handling plant, heating and cooling plant and electrical systems
- The BMS will allow optimum plant performance, energy usage, help to minimise energy consumption and provide the stated environmental conditions
- Mechanical / Electrical systems connected to the BMS system will include but is not limited to the following:
  - Incoming mains cold water utility meter
  - Incoming mains cold water utility meter (sprinkler)
  - Incoming electrical supply utility meter(s)
  - Electrical, water and heat sub-metering
  - Domestic hot and cold water services
  - Heating / Cooling plant
  - Heating distribution systems
  - Mechanical ventilation systems

## ENERGY METERING

- Energy metering will be provided as required by the Building Regulations and arranged to provide individual readings for all major energy sources
- Energy metering systems are installed that enable at least 90% of the estimated annual energy consumption of each fuel to be assigned to the various end-use categories of energy consumption
- The BMS will be used to monitor, record and store energy metering data for the following as a minimum:
  - Space heating
  - Lighting
  - Small power
  - Cold water usage
  - Hot water usage
  - Heating circuits
  - Fans (major)

## ELECTRICAL SPECIFICATION

### DESIGN CRITERIA

- The minimum design parameters that will be used in the electrical building services design for the office are as follows:

Item	Criteria
Electrical load allowance: (Before diversity is applied)	
Lighting	8W/m <sup>2</sup>
Small Power	25W/m <sup>2</sup>
Landlord Common Areas	5W/m <sup>2</sup>
Landlord Public Areas	2W/m <sup>2</sup>
Additional power for tenant use (catering etc.)	Up to 150kVA

### DETAILED SPECIFICATION

#### INCOMING POWER SUPPLY

- The supply to the building will be at the LV rate for Multi Tenancy but can be at the MV Rate for a Single Tenant
- The incoming power supply will have sufficient capacity to increase the contracted load by 25%
- The LV switch room will be designed to accommodate a main distribution board suitable for multi tenancy metering (have an automatic switchover to standby generator for a single occupancy), provision for power factor and surge protection equipment and have spare space of 10% for new equipment
- Switchgear shall be located in areas protected from flooding or water ingress

#### SWITCHGEAR & DISTRIBUTION BOARDS

- Each tenant will be provided with two electrical and two communications risers as per BCO 2014 requirements. These have been separated across the floor to provide diverse routes and therefore increase resilience. Communication risers have been developed in conjunction with WiredScore requirements
- Local distribution boards will be provided within landlord risers for the distribution and protection of power to final circuits
- Split boards for small power and lighting circuits will be used to rationalise the quantity of sub-mains cable feeds and distribution boards to each level
- Local distribution boards will be provided within all office tenant electrical risers. These will be connected to the main switchboard via individual submains to facilitate the future fit out of each level without the need to isolate power to the rest of the building. Split boards for small power and lighting circuits will be used to rationalise the quantity of sub-mains cable feeds and distribution boards to each level
- All distribution boards will be of a single manufacturer and of metallic construction. All boards will be lockable with a removable key
- All distribution boards will be provided with minimum 25% spare capacity

## STANDBY POWER SUPPLY

- A single life safety generator will be provided on the roof. This will be the secondary supply for the firefighting lift, smoke ventilation and sprinkler system. A space will also be provided on the roof to allow future tenants to provide their own generator as per WiredScore requirements

## POWER FACTOR CORRECTION

- Power factor correction equipment will be provided, if required, adjacent to the main LV switchboard
- The power factor of the supply will meet the minimum requirements as imposed by the electricity supplier (typically 0.95)

## SMALL POWER SYSTEMS

- Power to the various areas will be derived from distribution boards located in areas not normally accessed by the public or future tenants such as plant areas or electrical cupboards
- The distribution boards at each tenant floor will be served by a vertical busbar with a tap-off where required. The raised floor will allow for easy installation of floor boxes and underfloor data and power distribution
- Low voltage supplies shall be designed and installed to serve small power outlets for cleaning and maintenance purposes, spaced along circulation routes and within each landlord space, at 1 outlet every 10 m
- Supplies will be installed in each toilet/WC to supply hand dryers, disabled call alarms, showers and other small items of mechanical equipment
- Socket outlets will be installed at the main reception desk as well as any breakout spaces within the main lobby area
- Outlets will be generally recessed into the building in the areas visible to the public or surface mounted within some back of house areas such as plant rooms

## CABLE DISTRIBUTION

- A complete containment system will be provided within all risers and landlord spaces providing vertical and horizontal distribution of electrical systems
- Coordination between the structure and mechanical services has been undertaken to ensure a comprehensive electrical distribution system can be achieved to serve the building
- The containment systems will comprise the following separate systems:

System	Containment Type	Wiring System
LV Submains	Separate galvanised steel perforated tray for Essential and Non-Essential supplies	XLPE/LSF/SWA cable
Small power and lighting and final circuits	Separate galvanised steel trunking feeding conduit to outlet positions for Essential and Non-Essential supplies	LSF singles
Data cabling	Galvanised steel basket feeding conduit to outlet positions	Cat 6A cabling
ELV cabling (e.g. security, BMS, CCTV etc.)	Galvanised steel basket feeding conduit to outlet positions	As appropriate for system
Fire alarm	Galvanised steel tray or clipped direct as appropriate	BS 5839 compliant cabling



# IN-DEPTH SPECIFICATION

- Appropriate segregation between ELV and LV cabling systems will be achieved by appropriate containment mounted screening or spacing between systems to avoid signal interference to ELV cabling systems
- All cable containment (tray, basket, trunking, conduits, and underground uPVC ducts) will be suitably sized to allow for 25% spare capacity for future use

## WORKSTATIONS

- For the purposes of calculating electrical requirements workstations will be provided based on one per 8 m<sup>2</sup>
- Floor grommets will be provided at a rate of one per 8 m<sup>2</sup>
- Workstations will be served from busbar power modules located in the raised access floor with no more than four workstations per power module. Power modules to the desk are by the Tenant

## GENERAL & EMERGENCY LIGHTING

- A complete lighting scheme will be installed throughout the landlord areas of the building. The installation will generally use energy efficient LED luminaires utilising PIR detectors, photocells and variable dimming where appropriate. The lamp colour temperatures and associated colour rendering quality will be selected to suit the function of the departments or space

## FIRE ALARM INSTALLATION

- An open protocol addressable fire alarm system will be provided to landlord and Cat A areas in accordance with BS 5839: Part 1. The level of protection will be category L1
- The main panel will be located at the fire brigade arrival point (main entrance). It is anticipated that the alarm will be raised to the fire brigade either manually by staff or by automatic dialler. It is assumed that the fire brigade will report to the fire brigade arrival point on arrival to check the location of the fire and be able to operate the fire system controls as necessary
- Appropriate detection systems will be provided to landlord areas of the building to provide appropriate detection response times
- The building evacuation procedure will be phased. To enable this a voice alarm system will be used. This will involve speakers throughout the tenant and landlord areas. Each level will have its own amplifier to enable a phased evacuation

## EARTHING & BONDING

- An earthing and equipotential system will be provided in accordance with BS7671 and BS7430: Code of Practice for Earthing
- A lightning protection system will be provided in accordance with BS EN 62305

## ICT SYSTEMS

- A main ICT incoming communications room (MCR) will be provided at ground level to house landlord servers and incoming services. Floor mounted 42U IT cabinets will be provided, mounted on plinths complete with patch panels and power supplies. Active equipment, such as switches, wireless hubs and UPS units shall be provided by the tenant and/or their nominated representatives
- The ICT structured cabling within landlord areas will be designed in accordance with all relevant standards and this will generally be CAT 6a UTP cable mounted on cable basket in ceiling voids and 25 mm conduit to outlets. The quantities of data outlets will be agreed with the client during detailed design stage
- Two tenant risers dedicated for ICT use will be provided to each office. Separation between risers will be at least 7 m as required for WiredScore accreditation. Containment will be provided in each riser to allow future connection to each floor from the MCR in the form of 300 mm galvanised basket. All data systems within tenant spaces, including final connection to the MCR, will be provided as part of the tenant fit out of each office area and not the Cat A
- A passive wireless Local Area Network (LAN) infrastructure will be provided within landlord areas to provide coverage throughout the common areas and back of house spaces. The infrastructure shall comprise of two CAT 6a outlets provided at each point for connection of a wireless access point. The system shall be capable of operating separate networks simultaneously such as staff and public

## SECURITY

- The building will come complete with access control, CCTV and intruder alarm systems installed at main cores. CCTV cameras will be provided to cover public areas such as the main entrances and exit points, back of house areas and the building perimeter. The CCTV system shall be capable of providing imagery of a prosecution standard
- The proposed CCTV system will be an IP based solution which will run over the data network installation. This system offers flexibility to easily connect new or move IP cameras around the building if required. Increased functionality of the systems is also provided
- Recording and monitoring will be via a network video recorder located within the ground floor security room which will also accommodate the monitors, POE switches and shall be air conditioned. The system will be standalone with all recording within the building. However, the system will be capable of sending information externally as required by the landlord
- Landlord areas of the building will be provided with an IP based access control system, run over the building IT network, which shall restrict members of the public from entering back of house areas
- The access control system shall be controlled such that, in the event of a fire, the doors will automatically unlock in accordance with the agreed cause & effect schedule, which shall be developed during detailed design
- A zoned intruder detection system will be provided to allow certain areas of the building to be secured and monitored out of working hours
- Detection will be by means of motion detectors to areas with accessible external elevations and door contacts to all external doors
- A security panel with adjacent keypad will be located at the main entrance

## LIFTS

- Lifts will be provided in accordance with BS EN 81 to facilitate vertical people access and/or for the safe transportation of furniture, equipment or supplies
- The lifts will conform to all disabled user requirements
- Lifts will be of the machine room-less type with a maintenance access panel located on the highest floor served
- Lift car interior lighting will be arranged with facilities to automatically switch off the internal car lights when a lift is not in use over an extended period
- Interfaces/connections will be provided for all necessary items such as fire alarms and access control

The design criteria for lift analysis is based on BCO 2014 as summarised below:

Occupancy	One workstation per 10 m <sup>2</sup> NIA
Attendance	80%
Handling capacity	Morning: 12% in five minutes (85% up, 10% down, 5% inter-floor) Lunch: 13% in five minutes (45% up, 45% down, 10% inter-floor)
Average waiting time (AWT)	Morning: less than 25 seconds with time to destination less than 90 seconds Lunch: Less than 40 seconds
Maximum lift occupancy	80% of rated capacity

- A total of six passenger lifts will be provided within the building with lift analysis complete to satisfy BCO 2014 requirements
- Two lifts within core 1 will be firefighting lifts. The goods lift is remote from the main lift block and will not form part of the main destination control system

## PLANT SPACE AND RISER STRATEGY

### MINIMUM SERVICE ZONES

- Floor void 150 mm including tile
- Ceiling void 500 mm including tile (on lower floors)

### VERTICAL DISTRIBUTION

- Vertical service risers will have spare capacity to accommodate specialist tenant services, such as but not limited to, kitchen/restaurant area
- A minimum of two, dedicated structured cabling risers are available for tenant use

### TENANT PLANT SPACE

The following tenant plant areas have been allocated:

- Air cooled condensers for computer rooms
- Tenant generator space
- Restaurant ventilation plant

### UNINTERRUPTED POWER SUPPLY (UPS)

- To be provided by the tenant

## PUBLIC UTILITIES

### DATA / COMMUNICATIONS

- WiredScore Platinum certified
- In line with WiredScore criteria, multiple intake cable entry points will be provided into the building from different locations or sides of the building. This creates a physical separation so that if the connectivity on one side of the building is disrupted (construction, fire, flooding, etc.), connectivity from the other side can still be functional. Two 100 mm duct entry points will be provided from different sides (four in total) to the MCR at ground level. Entry conduits will be built sloping away from the building to prevent water ingress
- Multiple A & B risers will transverse throughout the building, from basement to roof, allowing tenants a resilient communication utility connection

## TESTING AND COMMISSIONING

- All systems shall be commissioned in accordance with CIBSE and BSRIA codes, including controls and Building Management Systems
- Record Drawings and Safety File will be provided in digital format

## KEY SUSTAINABILITY

- BREEAM Excellent
- High Target of BER
- LED lighting throughout
- Energy efficient equipment including the use of premium efficiency motors with variable frequency drives where practical (fans, pumps, lifts)
- High efficiency, gas fired condensing boilers
- Specification of high efficiency cooling plant
- Zoning of equipment to allow plant to be turned off, or enable out of hours setback, in appropriate unoccupied spaces
- Central BMS with monitoring of key system parameters for necessary regulation

# PROFESSIONAL TEAM

Developer

W I R E F O X

Project Manager, Quantity Surveyor,  
Principal Designer

**bruceshaw.**

Architect

**TODD**

M&E and Civils Consultant

ARUP

Structural Engineer

TAYLOR  
+BOYD

Planning Consultant

**TSA** PLANNING

Fire Consultant

 **JGA**  
A JENSEN HUGHES COMPANY



# CONTACT

## FIND OUT MORE



### NEAL MORRISON

T: +44 28 9026 7824  
M: +44 77 4039 3733  
E: Neal.Morrison@savills.ie

[www.savills.ie](http://www.savills.ie)



### IAN DUDDY

T: +44 28 9051 1003  
M: +44 77 3050 2897  
E: Ian.Duddy@colliers.com

[www.colliers.com](http://www.colliers.com)

[www.thepaperexchange.co.uk](http://www.thepaperexchange.co.uk)

#### Disclaimer

Savills & Colliers International, their clients and any joint agents give notice that:

1. They are not authorised to make or give any representations or warranties in relation to the property either here or elsewhere, either on their own behalf or on behalf of their client or otherwise. They assume no responsibility for any statement that may be made in these particulars. These particulars do not form part of any offer or contract and must not be relied upon as statements or representations of fact.
2. Any areas, measurements or distances are approximate. The text, photographs and plans are for guidance only and are not necessarily comprehensive. It should not be assumed that the property has all necessary planning, building regulation or other consents and Savills & Colliers International have not tested any services, equipment or facilities. Purchasers must satisfy themselves by inspection or otherwise.

Images: Page 20 - Courtesy of Tourism Northern Ireland, Page 22 - © Beannchor Group Limited, Pages 24+25 - © Beannchor Group Limited, Page 26 - © Coppi Restaurants Limited, © Yugo Belfast, Page 27 - © Beannchor Group Limited, Courtesy of The Pocket Flatiron - © SJP Photography, Page 28 - Courtesy of Tourism Northern Ireland, © Beannchor Group Limited, Page 29 - Courtesy of Tourism Northern Ireland, © Hastings Hotels Limited, Pages 30+31 - Courtesy of Tourism Northern Ireland, Page 34 - Copyright Christopher Heaney.

Photography displayed within these particulars is done so with permission of the copyright owner. All rights are reserved.

January 2020.



Gratchwell St.

THE PAPER EXCHANGE



WIREFOX

# THE PAPER